

3D MODEL GUIDE		
RANGE	DJ PNEUMATIC PUSH	
	AXIAL	R/A
2mm	DJ2P	DJR2P
5mm	DJ5P	DJR5P
10mm	DJ10P	DJR10P
10/2mm	DJ10-2P	DJR10-2P
12mm	DJ12P	DJR12P
20mm	DJ20P	DJR20P

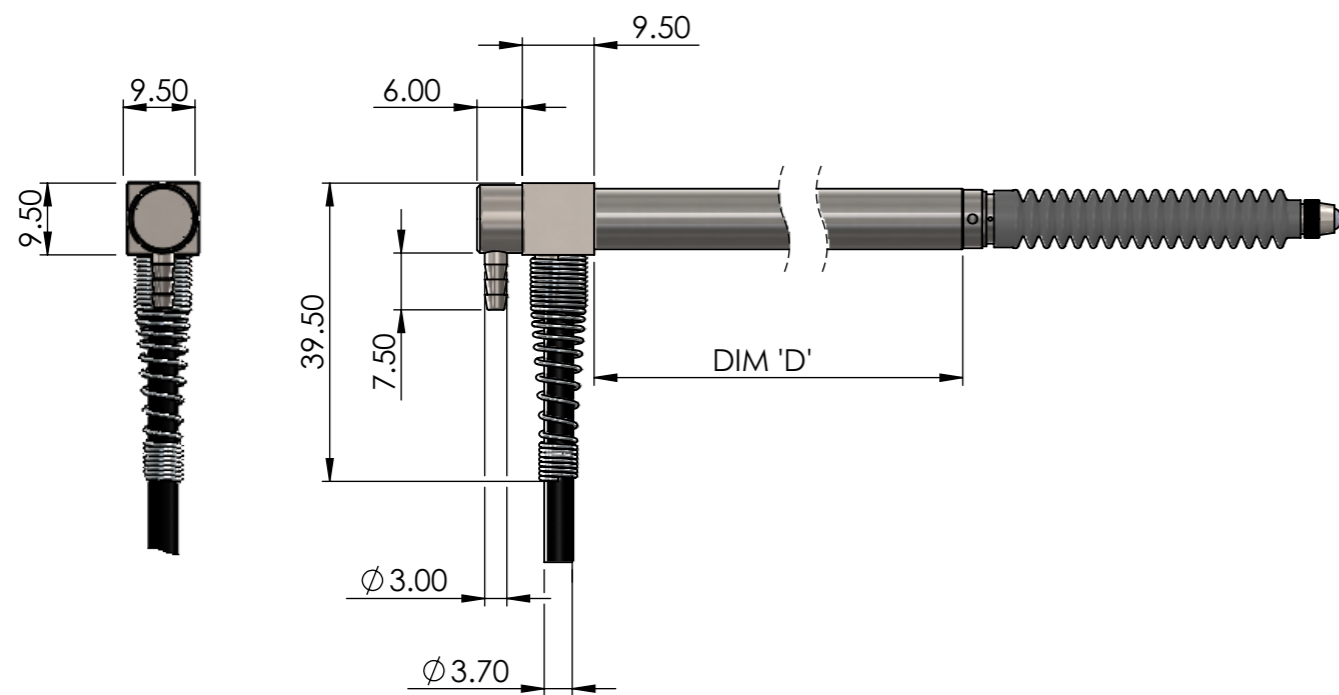
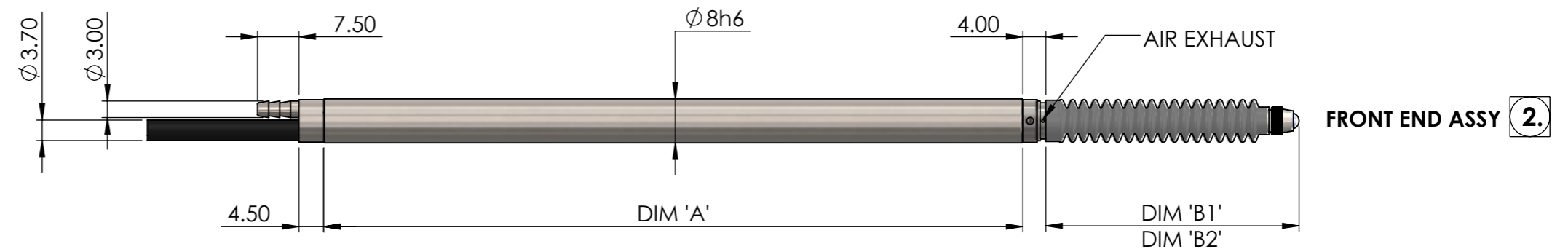
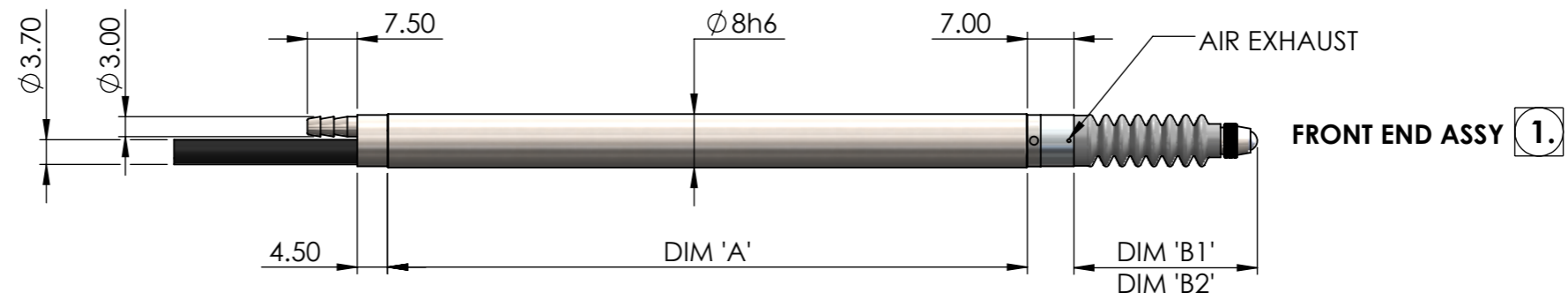

RADIAL CABLE OUTLET OPTION 'R/A'

MEASUREMENT RANGE	2mm	5mm	10mm	10/2mm	12mm	20mm
CASE LENGTH AXIAL DIM 'A'	52.50	71.00	96.00	84.00	127.00	127.00
CASE LENGTH R/A DIM 'D'	38.50	57.50	82.50	-	113.50	113.50
FULLY EXTENDED DIM 'B1'	16.25	20.00	27.50	27.50	28.50	46.00
PRE-TRAVEL	0.15	0.15	0.15	0.15	0.15	0.15
POST-TRAVEL	0.85	0.85	0.85	8.85	0.85	0.85
FULLY RETRACTED DIM 'B2'	13.25	14.00	16.50	16.50	5.50	25.00
FRONT END ASSY TYPE	(1.)	(1.)	(1.)	(1.)	(1.)	(2.)