



Solartron
Metrology

OD5 Conditioning Modules



user manual

AMETEK[®]
ULTRA PRECISION TECHNOLOGIES

Index

Section	Title	Page	Section	Title	Page
1.0	Index	1	4.6.2	Current Connections	12
2.0	Safety Information	2	4.7	Using an EMC Cable Gland	13
3.0	Introduction	5	5.0	Setting up the Transducer and OD5	14
3.1	OD5 MK2 Enhancements	5	5.1	Option Links Explained	15
4.0	Installation	6	5.2	Basic Procedure	16
4.1	Mounting	6	5.3	Sensitivity and the X2, X4, DIV2 Links	20
4.2	Operational Environment	7	6.0	Half-Bridge Version.	21
4.2.1	Residential, Commercial & Light Industrial Environments	7	7.0	Specifications	22
4.2.2	Industrial Environments	7	7.1	Electrical	22
4.3	Electrical Connections	8	7.2	Mechanical and Connections	24
4.4	Connecting the Transducer	9	7.3	Environmental.	24
4.5	Mains Power Supply	10	7.4	Notes	25
4.6	Connecting the Signal Out	11		Return Of Goods	
4.6.1	Voltage Connections	11		Solartron Sales Offices	

2.0 Safety Information

Terms in this Manual

WARNING statements identify conditions or practices that could result in personal injury or loss of life.

CAUTION statements identify conditions or practices that could result in damage to the equipment or other property.

Symbols in this manual



This symbol indicates where applicable cautionary or other information is to be found.

WARNINGS:

Do not operate in explosive atmosphere

To avoid explosion, do not operate this equipment in an explosive atmosphere.

Installation Environment

The power supply unit is for indoor use only. It should not be mounted where ingress of fluids is possible.

Safety Critical Environments

This equipment is not intended for use in a safety critical environment.

Power Source

Apply no more than 264 VAC between mains supply pins and ground.

2.0 Safety Information

Service Safety

Safety Compliance Statement

OD5 is designed as Safety Class 2 apparatus with functional ground to comply with IEC 61010-1. The power supply unit is marked as compliant with EN60950-1, but when as part of the OD5 assembly and installed by qualified personnel according to these user instructions, then IEC 61010-1 compliance can be achieved.

This equipment has been designed and tested to meet the requirements of the Low Voltage Directive (73/23/EEC 1997) and has been supplied in a safe condition. This manual contains information and warnings that must be followed by the user to ensure safe operation and to maintain the apparatus in a safe condition.

Notes

Ground Connection

This equipment is supplied with a mains ground connection. This is a functional ground only. Loss of ground connection may result in an AC voltage between accessible parts of the OD5 and reference earth. The voltage, current or charge is at a safe level.

The power supply unit contains no user serviceable parts

This equipment must be returned to your dealer for all servicing and repair.

2.0 Safety Information

CAUTION:

Electrostatic Discharge

This equipment is susceptible to **ESD** (Electrostatic Discharge) when being installed or adjusted, or whenever the case cover is removed. To prevent ESD related damage, handle the conditioning electronics by its case and do not touch the connector pins. During installation, follow the guidelines below.

- Ensure all power supplies are turned off.
- If possible, wear an ESD strap connected to ground. If this is not possible, discharge yourself by touching a metal part of the equipment into which the conditioning electronics is being installed.
- Connect the transducer and power supplies with the power switched off.
- Ensure any tools used are discharged by contacting them against a metal part of the equipment into which the conditioning electronics is being installed.
- During setting up of the conditioning electronics, make link configuration changes with the power supply turned off. Avoid touching any other components.
- Make the final gain and offset potentiometer adjustments, with power applied, using an appropriate potentiometer adjustment tool or a small insulated screwdriver.

CAUTION:

Fuse Rating

The OD5 power supply unit does not need a fuse for safe operation. However, wiring to the OD5 power supply unit may need to be fused. If the mains lead supplied with your OD5 has a fuse incorporated into the plug, then a fuse of the same type and value should replace it. Otherwise, fusing and wiring to the OD5 must be performed in accordance with local safety regulations. Refer wiring and fuse replacement to qualified personnel.

3.0 Introduction

The OD5 MK2 is a development of the original OD5. It is a compact conditioning module powered from an external power supply unit. Adjustable gain and zero controls are provided for use with the complete range of Solartron LVDT and half-bridge transducers*. The unit is of robust construction, housed in a die cast metal box providing a substantial degree of mechanical protection.

The OD5 MK2 uses a universal mains input power supply and provides an output of up to ± 10 V and ± 20 mA.

3.1: OD5 MK2 Enhancements

The OD5 MK2 has the following features.

- Wide gain range, allowing ALL Solartron transducers to be connected without the need for attenuation resistors.
- Up to ± 10 V dc and ± 20 mA are available for all gain settings.
- Fixed and variable offsets make setting of uni-polar output easier.
- Gain and offset adjustment are fully independent.
- Selectable transducer excitation frequency.
- Selectable transducer load resistances.
- Selection between forward and reverse connection.
- Fully CE compliant.
- Half-Bridge transducers can be accommodated with simple plug wiring changes.*

* For half-bridge only variant see section 6.0

4.0 Installation

4.1: Mounting

The OD5 may be mounted in a variety of ways and in any attitude. Ensure that there is enough space for the cover to be removed to allow for internal adjustments. Space should also be allowed for the transducer connector, EMC glands (if fitted) and cabling. It is recommended that the OD5 case be connected to earth or chassis. This earth connection is not a safety earth, but is part of the overall electrical screening scheme.

The power supply may be mounted in any position. The power supply is for indoor use only and must be protected from fluids. Ensure that the power supply can be disconnected from the mains. This can be by removing the plug from the power supply itself, or by disconnection from the mains source. Also ensure that the mains lead cannot be accidentally disconnected.

Underside Mounting

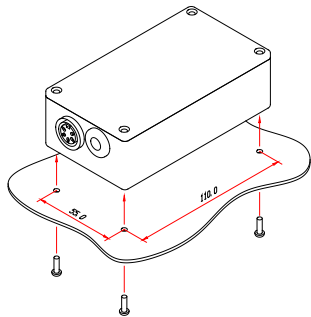

Top-Side Mounting

Note: If replacing OD5 MK1 a retrofit mounting kit is available if repositioning holes is not possible.

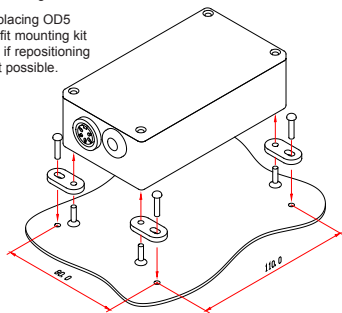

4.0 Installation (cont.)

4.2: Operational Environment

This section discusses the type of installation required depending on the electrical environment.

4.2.1: Residential, Commercial and Light Industrial Environments

Typically, this will be an office, laboratory or industrial environment where there is no equipment likely to produce high levels of electrical interference, such as welders or machine tools.

Connections may be made using twisted, unshielded wire. This is a cost effective option and will give good performance in this environment.

Standard equipment wire such as 7/0.2 (24AWG) can be twisted together as required. Standard data cable such as generic CAT5 UTP will also give good performance.

4.2.2: Industrial Environments

Typically, this will be an industrial environment where there is equipment likely to produce high levels of electrical interference, such as welders, machine tools, cutting and stamping machines.

Connections should be made using screened cable. Braided or foil screened cables may be used. The cable screen should be connected to the OD5 case at cable entry point. The case of the OD5 should be connected to a local ground. An EMC cable gland is recommended. This is supplied with the OD5.

When selecting the type or wire or cable to be used, consider the following parameters:

- Screening.
- Conductor size (resistance).
- Mechanical aspects such as flexibility and robustness.

This is not a complete list. Installations may require other special cable characteristics.

4.0 Installation (cont.)

4.3: Electrical Connections

The OD5 requires three connections.

1. Transducer
2. Mains power supply.
3. Output signal, voltage or current.

A small hole should be made in the grommet prior to passing the wires through. If a screened cable is to be used, an EMC cable gland is recommended.

For best performance in electrically noisy environments, the case of the OD5 should be connected to a local earth. This can be achieved via the mounting bracket. This earth connection is not a safety earth, but is part of the overall electrical screening scheme.

The wiring layout arrangements are similar for OD5 fitted with EMC glands and screened cable.

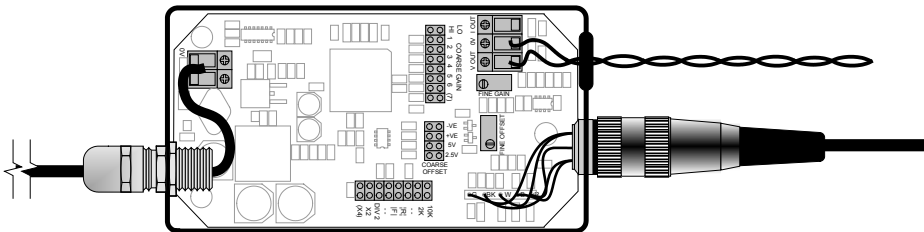

A technical note explaining good practice for cable installation and routing can be downloaded from www.solartronmetrology.com.

4.0 Installation (cont.)

4.4: Connecting the Transducer

Transducers fitted with a 5-pin DIN plug are simply screwed into the case mounted socket. Transducers not fitted with a plug should be wired to the plug supplied. For the half-bridge only variant see section 6.0.

LVDT Electrical Connections	
Red and Blue	Energising
Green and White	Signal
Yellow	Secondary Centre Tap
Red and White	In Phase for Inward Displacement
Black	Transducer Body Ground

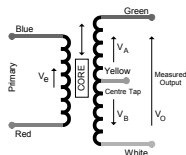

Half-Bridge Electrical Connections	
Red and Blue	Energising
Yellow	Signal
Red and Yellow	In Phase for Inward Displacement
Black	Transducer Body Ground

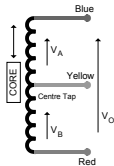

Standard LVDT Gauging Probe Plug Connections

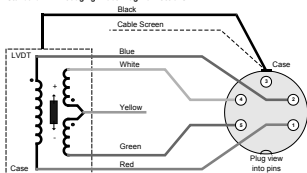

Note 1: + indicates inward movement of the tip.

Note 2: The transducer body may be disconnected from the cable screen by cutting the black wire inside the connector

Standard Half-Bridge Gauging Probe Plug Connections

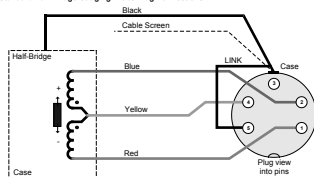

Note 1: + indicates inward movement of the tip.

Note 2: The transducer body may be disconnected from the cable screen by cutting the black wire inside the connector

4.0 Installation (cont.)

4.5: Mains Power Supply

The mains adaptor is pre-wired to the OD5. This is a universal power adaptor, so no adjustments are required for mains frequency or voltage. Please review safety statements and installation section.

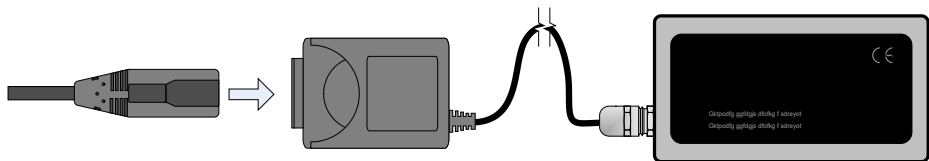

WARNING:

Ensure that the local safety precautions are observed for installation of mains equipment.

4.0 Installation (cont.)

4.6: Connecting the Signal Out

The output signal may be voltage or current.

4.6.1: Voltage Connections

Voltage is most easily be monitored using a variety of instrumentation such as voltmeters. Voltage drops along wires contribute to measurement errors, so care must be taken when using long cable lengths (100 m for example). High impedance instruments are more prone to interference.

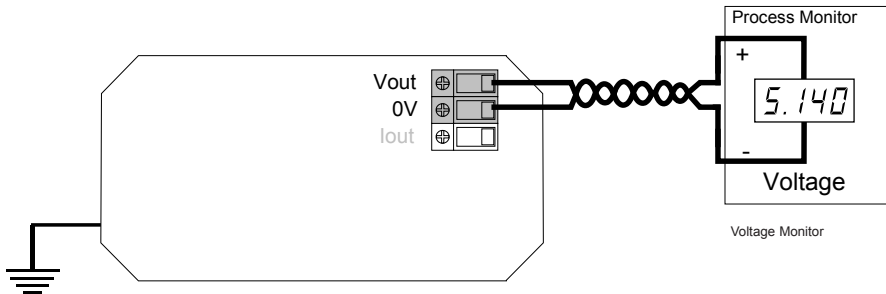

4.0 Installation (cont.)

4.6.2: Current Connections

Current output requires the use of purposely designed current input instrumentation. Current output is more suitable for transmitting over longer distances because current is not lost due to wiring resistance. Additionally, with a low impedance, a current loop is less likely to pick up noise.

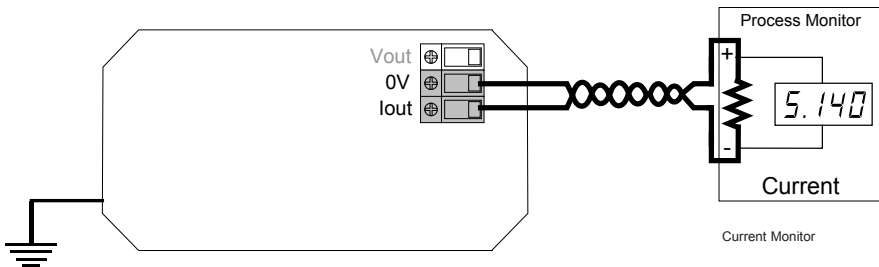

4.0 Installation (cont.)

4.7: Using an EMC Cable Gland

To ensure the cable screen is properly connected to the OD5 case, an EMC cable gland should be used. This is supplied as an extra. The diagrams below assume a single 4-way cable is being used. Remove the grommet and fit the cable gland as shown below.

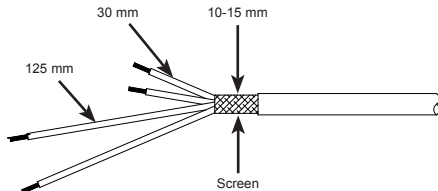
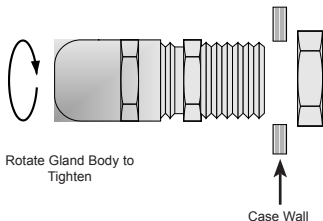

- Prepare cable as shown.
- Slide the Dome nut, sealing ring and plastic insert over cable.
- Fold and roll the screen back over itself to form a lump.
- Push cable into gland body followed by the plastic insert (ensure anti-rotation slots engage), sealing ring and Dome nut.
- Ensure all components are properly seated before tightening the Dome nut.

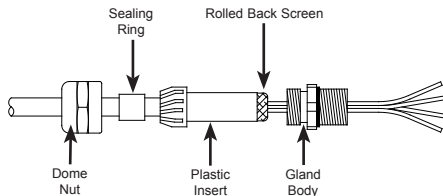

5.0 Setting up the Transducer and OD5

The OD5 may be set-up with output signals anywhere within a ± 10 VDC or ± 20 mA range. Typical outputs are ± 10 VDC, ± 5 VDC, 0-10 VDC and 4-20 mA. These procedures apply to voltage and current output.

Voltage and current output are available at the same time, although they cannot be individually adjusted. Either voltage or current should be chosen as the calibration reference.

All outputs use 0 V signal as the signal reference.

A list of standard link settings is available, see section 5.2.



CAUTION:

During installation and adjustment, the top of the enclosure has to be removed for access to user adjustments. At this time, standard ESD handling precautions for electronic equipment should be followed.

5.0 Setting up the Transducer and OD5 (cont.)

5.1: Option Links - Explained

The table below and subsequent diagrams explain the link functions and show the factory setting.

Link	Description	Options	Standard Setting
Course Gain	Sets the basic gain	1 link on Positron 1 to 6	Link ON Position 1
Fine Gain	Adjustment between course gain ranges	Potentiometer Adjustment	Mid Position
Course Offset	Shifts the output by a fixed amount	Link ON -VE or +VE and Link ON 5V or 10V No offset - Link Parked	No offset - Links Parked
Fine Offset	Fine trim around any fixed offset	Potentiometer Adjustment	Mid Position
(7) Null	Used during set-up to null output	ON, OFF	OFF
Freq.	Selects transducer primary frequency	Lo - ON, Hi - Parked	Hi Freq. - Link Parked
Input Resistance	Sets transducer secondary load	100k Ω Parked, 10k Ω - ON, 2k Ω - ON	100K Ω - Link Parked
Polarity (FR)	Enables output signal direction change	2 Links across Forward or Reverse	F Position - 2 Link ON
Input Gain	Input Gain of x1, x2, x4 or divide 2	X1 - Parked, X2 - ON, X4 - ON, DIV2 - ON	Link parked on X2

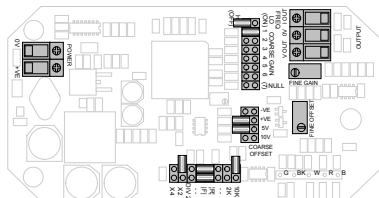

5.0 Setting up the Transducer and OD5 (cont.)

5.2: Basic Procedure

To set-up the OD5, some basic steps should be followed.

The following steps describe a typical setting procedure and applies to most applications. Other procedures may be used as appropriate.

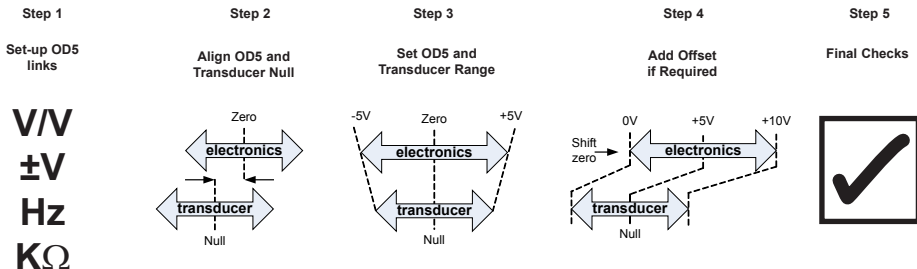

For a bi-polar output i.e. ± 10 VDC or ± 20 mA, follow steps 1 to 3.

For a uni-polar output i.e. 0-10 V, 0-20 mA or 4-20 mA, follow steps 1 to 4.

In either case, step 5 (final checks) should be followed on the completion of the set-up.

5.0 Setting up the Transducer and OD5 (cont.)

5.2: Basic Procedure

STEP 1 - Set-up OD5 Links

If the transducer characteristics are known, set the frequency and input resistance links as required. A list of standard settings for all Solartron transducers is available from www.solartronmetrology.com. If the transducer characteristics are not known, the standard link settings should be used.

If your transducer is known to be outside of the standard sensitivity range, the X2 or DIV2 links will have to be used. See section 5.3.

STEP 2 - Align OD5 Null and Transducer Null

Any electrical offset in the OD5 is removed. The transducer position is adjusted so that transducer and OD5 nulls are aligned.

Null the OD5.

1. Put the Gain link on position (7) as shown. This allows any electronics offset in the output stage to be removed.
2. Adjust the Fine Offset control to give as near to zero output as practical.

Null the transducer.

1. Replace the Gain link to the original position.
2. Adjust the position of the transducer to give as near to zero output as practical.
This is the centre of the mechanical range.

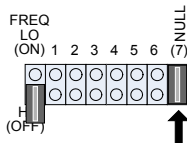

If the transducer cannot be centered for practical reasons an offset will remain within the system. There may be noticeable interaction between Gain and Offset adjustment. This does not prevent the OD5 being set-up, however several iterations may be required when adjusting Gain and Offset. Please contact your supplier if guidance is required.

5.0 Setting up the Transducer and OD5 (cont.)

5.2: Basic Procedure

STEP 3 - Setting Bi-Polar Full-Scale Output

1. Move the transducer to the position where maximum OD5 output is required.
2. If the polarity of the output is wrong, move the Polarity (FR) links to the R position (see link diagram).

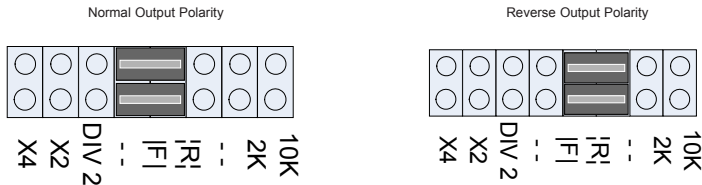

3. Move the RANGE link between 1 and 6 until the OD5 output is near the required value.
4. Adjust the Fine Gain control to give the required output.
5. A bi-polar output has now been set, proceed to step 5. If a uni-polar output is required, proceed to step 4.

Example: ± 10 VDC is required from a ± 1 mm transducer. Set the transducer to the +1 mm position and set the output to 10 V.

If your transducer is known to be outside of the standard sensitivity range, the X2 or DIV2 links will have to be used. See section 5.3.

5.0 Setting up the Transducer and OD5 (cont.)

5.2: Basic Procedure

STEP 4 - Setting Uni-Polar Full-Scale Output (adding an offset)

1. Move the transducer to the null position. OD5 output will be 0 V or 0 mA.
2. Apply offset using the +VE, -VE, 5 V and 10 V links and then adjust the Fine Offset control to set the offset precisely.
3. Perform final checks, step 5.

Example: 0-10 V is required for a ± 1 mm transducer. Set the transducer to give ± 5 V over the full range and then, with the transducer at null, add +5 V offset. Adjust the Fine Offset control to give 5 V. When the transducer is moved to the +1 mm position, the output will be +10 V.

Example: 4-20 mA is required for a ± 1 mm transducer. Set the transducer to give ± 8 mA over the full range and then, with the transducer at null, add +5 V (approx. 10 mA) offset. Adjust the Fine Offset control to give +12 mA. When the transducer is moved to the +1 mm position, the output will be +20 mA.

STEP 5 - Final Checks

Ensure that the calibration is correct by moving the transducer across the required mechanical range, checking calibration points. Fine adjustment can be made if required.

It may only be possible to set the output accurately at the two calibration points. This is due to non-linearity within the transducer.

5.0 Setting up the Transducer and OD5 (cont.)

5.3: Transducer Sensitivity and the X2, X4, DIV2 Link

The OD5 compensates for changes in primary signal amplitude by producing an internal error signal that is the ratio between the primary and secondary signals. If the transducer output signal is too high or too low, errors may occur that can degrade the performance of the OD5 / transducer combination. For these transducers, the X2, X4 or DIV2 input gain link must be used.

For Solartron transducers, consult the list of standard settings available from www.solartronmetrology.com.

Transducer Full Range Output

In general, transducer sensitivity is quoted as **mV/V/mm**

Where: **mV** is the output of the transducer
V is the primary voltage
mm is the mechanical position of the transducer from null (usually mid mechanical range).

To get the transducer Full Range Output, multiply all three together.

Example: AX/1.0 sensitivity is 210 mV/V/mm
AX/1.0 range is ± 1 mm
OD5 primary voltage 3 V

$$\text{Transducer Full Range Output} = 210 \times 3 \times 1 = 630 \text{ mV (0.63 V)}$$

Set the X2, X4, DIV2 link as shown in the table below.

Transducer Full Range Output	Input Gain Link Setting
400 mV FR to 2500 mV FR	Standard Range - Link Parked on X2
2500 mV FR to 5000 mV FR	High Transducer Output - Link ON DIV2
150 mV FR to 400 mV FR	Low Transducer Output - Link ON X2
55 mV FR to 150 mV FR	Very Low Transducer Output - Link ON X4

6.0 Half-Bridge Only Variant

This is a Half-Bridge optimised variant of the standard product. The excitation frequency is higher (see specification) and the transducer input connector is wired to accept half-bridge transducers with standard connections.

6.1: Connecting the transducer

The 5-pin DIN plug is screwed into the case mounted socket. Transducers not fitted with a plug should be wired to the plug supplied. LVDT transducers cannot be connected to this input.

Standard Half-Bridge Gauging Probe Plug Connections

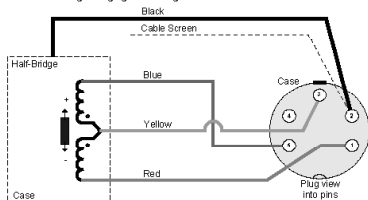

Note 1: + indicates inward movement of the tip.
Note 2: The transducer body may be disconnected from the cable screen by cutting the black wire inside the connector

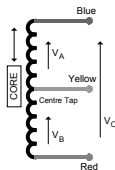

Half-Bridge Electrical Connections

Red and Blue	Energising
Yellow	Signal
Red and Yellow	In Phase for Inward Displacement
Black	Transducer Body Ground

6.2: Setting up the Half-Bridge Transducer

The setting up procedure is the same as LVDT transducers. See section 5. The sensitivity of half-bridge transducers is generally lower than for LVDT types, the x2 and x4 gain position may have to be used. A list of standard link settings for all Solartron Transducers is available from www.solartronmetrology.com.

7.0 Specifications

7.1: Electrical

Specifications are for the OD5 only. Effects due to transducers are not included. Output is set to ± 10 VDC into a $1\text{ k}\Omega$ load, unless specified differently. FRO means 'Full Range Output'.

Parameter	Value	Comments
Power Supply		
Mains Voltage	90 to 264 VAC	Full PSU specification can be supplied on request
AC Input Frequency	47 to 86 Hz	
AC Input Current	0.25 A (120 VAC), 0.1 A (250 VAC)	
Transducer Excitation		
Energising Voltage	3 Vrms nominal	see note 1
Energising Frequency	2.5 kHz (Lo) or 5 kHz (Hi) nominal 10 kHz (Lo) or 13 kHz (Hi)	link selectable Half-Bridge version only
Energising Current	30 mA max.	
Transducer Signal Input		
Input Signal Range	Standard	400 to 2500 mV FR
	Special	DIV2 2500 to 500 mV FR x2 150 to 400 mV FR x4 55 to 150 mV FR
Input Load Resistance	2, 10, 10 $\text{k}\Omega$	6 gain ranges (applies to LVDT only)
Options	Forward and Reverse LVDT Input Half-Bridge Input	link selectable standard special plug wiring or half-bridge version only

7.0 Specifications (cont.)

7.1: Electrical

Parameter	Parameter	Comments
Signal Output		
Output Voltage Range	Up to ± 10 VDC into 1 k Ω min	see notes 3 and 4
Output Residual Noise	<1 mV rms	
Output Current	Up to ± 20 mA into 150 Ω load	see note 5
Output Offset		
Coarse	± 5 VDC (approx 10 mA) fixed	link selectable
	± 10 VDC (approx 10 mA) fixed	link selectable
Fine	± 2.8 VDC (approx 5.6 mA)	Variable (adds to fixed offsets)
Temperature Coefficient		
Gain	<0.01% FRO/ $^{\circ}$ C	
Offset	<0.01% FRO/ $^{\circ}$ C	
Warm-Up	15 minutes recommended	
Linearity	<0.1% FRO	
Bandwidth (-3dB)	500 Hz typical	
Protection (see note 6)		
Inputs and Outputs	Short circuit protected	
	Transient and ESD Protected	
Certification (see note 7)		
Immunity	BS EN61000-6-2:2001	Immunity for Industrial Environments
Emissions	BS EN61000-6-3:2001	Emission for Residential, commercial and light-industrial environments
Power Supply Safety Approvals	TUV EN60950, CE, CSA22.2, UL1950	
Overall Safety Approval	Compatible with IEC 61010-1	See note 8

7.0 Specifications (cont.)

7.2: Mechanical and Connections

Parameter	Value	Comments
Transducer	5-pin circular DIN	
Power Supply Cable Length	1.8m maximum, fixed length	Adaptor to OD5 case
Mains Connector	IEC320 C14	C13 Mains lead supplied as required
Output Signal	Internal terminal block	
Enclosure	Size	120 x 65 x 40 mm
	Weight	300g approximately
	Material	Die-cast Zinc Alloy (painted)
Power Supply	Size	65 x 49 x 33 mm
	Weight	120 g approximately

7.3: Environmental

Parameter	Value	Comments
Operating Temperature Range	0 - 60°C	see note 9
Storage Temperature Range	-20 - 85°C	
IP Rating	IP40	

7.0 Specifications (cont.)

7.4: Notes

1. Primary voltage absolute value and drift are not specified. The OD5 uses ratiometric techniques to compensate for primary voltage drift.
2. The way in which the OD5 functions means a special configuration must be used for transducers outside of the standard range. This is selectable by links. The majority of Solartron LVDT transducers are within the standard range. The user manual provides details of the selection criteria.
3. OD5 can drive into a 1 k Ω load but this offers no advantage. 10-100 k Ω is recommended.
4. Output voltage range can be adjusted as required anywhere within this range by using a combination of gain and offset, for example, ± 10 VDC, ± 5 VDC, 0-5 VDC, 0-10 VDC, 4-20 mA. See user manual for adjustment method.
5. Current output may be used at the same time as voltage output. Calibration of voltage and current cannot be individually adjusted.
6. Protection applies to the product when fully installed according to the user manual. During installation the top of the enclosure has to be removed for access to user adjustments. At this time standard ESD handling precautions for electronic equipment should be followed.
7. The OD5 complies with the toughest electrical emissions regulations. The power supply unit alone is only compliant with BS EN61000-6-1:2001 (Immunity for residential, commercial and light-industrial environments). However, when used as part of the OD5 assembly, the compliance levels are extended to BS EN61000-6-2:2001 (Immunity for industrial environments). Compliance requires installation according to user manual. The flexibility of OD5 means it can be installed in a variety of ways according to user requirements. Simple installations with short non-screened cables will meet the lesser light-industrial immunity regulations. Heavy industrial installations, especially with longer cables, will need more careful installation with screened cables.

7.0 Specifications (cont.)

7.4: Notes

8. The power supply unit alone is certified as described. When used as part of the OD5 and installed as described in the user manual, then compliance with IEC 61010-1 can be achieved.
9. The OD5 itself has a 0 - 60 °C specification. The power supply will function over a wider temperature range, but the safety approval is only valid for 0 - 50 °C.
10. The OD5 MK2 enclosure is smaller than the old model. This means that it will fit into all existing applications. Mounting holes may need to be re-drilled. Extra mounting bars are available for situations where this is not possible.